

LMV227

Production RF Tested, RF Power Detector for CDMA and WCDMA

General Description

The LMV227 is a 30 dB RF power detector intended for use in CDMA and WCDMA applications. The device has an RF frequency range from 450 MHz to 2 GHz. It provides an accurate temperature and supply compensated output voltage that relates linearly to the RF input power in dBm. The circuit operates with a single supply from 2.7V to 5V. The LMV227 has an integrated filter for low-ripple average power detection of CDMA signals with 30 dB dynamic range. Additional filtering can be applied using a single external capacitor.

The LMV227 has an RF power detection range from -30 dBm to 0 dBm and is ideally suited for direct use in combination with resistive taps. The device is active for Enable = HI, otherwise it goes into a low power consumption shutdown mode. During shutdown the output will be LOW. The output voltage ranges from 0.2V to 2V and can be scaled down to meet ADC input range requirements. The output signal bandwidth can optionally be lowered externally as well.

Features

- 30 dB linear in dB power detection range
- Output voltage range 0.2 to 2V
- Logic low shutdown
- Multi-band operation from 450 MHz to 2000 MHz
- Accurate temperature compensation

Applications

- CDMA RF power control
- WCDMA RF power control
- CDMA2000 RF power control
- PA modules

Typical Application

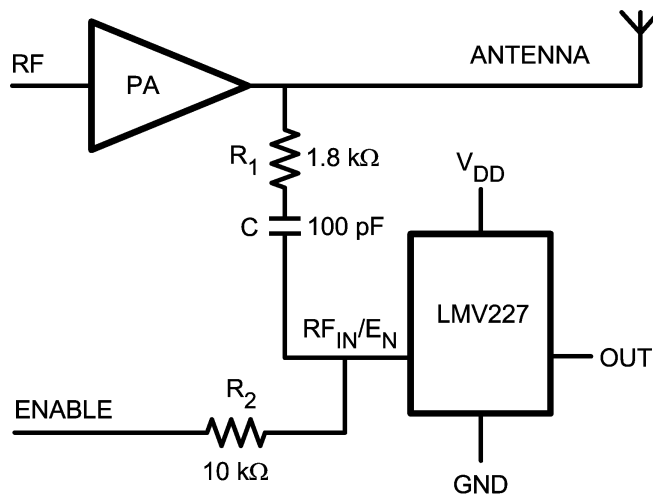

Absolute Maximum Ratings (Note 1)

If Military/Aerospace specified devices are required, please contact the National Semiconductor Sales Office/Distributors for availability and specifications.

Supply Voltage	
$V_{DD} - GND$	6.0V Max
ESD Tolerance (Note 2)	
Human Body Model	2000V
Machine Model	200V

Storage Temperature Range	-65°C to 150°C
Junction Temperature (Note 3)	150°C Max
Mounting Temperature	
Infrared or convection (20 sec)	235°C

Operating Ratings (Note 1)

Supply Voltage	2.7V to 5.5V
Temperature Range	-40°C to +85°C

2.7 DC and AC Electrical Characteristics

Unless otherwise specified, all limits are guaranteed to $V_{DD} = 2.7V$; $T_J = 25^\circ C$. **Boldface** limits apply at temperature extremes. (Note 4)

Symbol	Parameter	Condition	Min	Typ	Max	Units
I_{DD}	Supply Current	Active mode: $RF_{IN}/E_N = V_{DD}$ (DC), No RF Input Power Present.		4.9	7 8	mA
		Shutdown: $RF_{IN}/E_N = GND$ (DC), No RF Input Power Present.		0.6	4.5	μA
V_{LOW}	E_N Logic Low Input Level (Note 6)				0.8	V
V_{HIGH}	E_N Logic High Input Level (Note 6)		1.8			V
t_{on}	Turn-on- Time	No RF Input Power Present		2.1		μs
t_r	Rise Time (Note 7)	Step from No Power to 0 dBm Applied		4.5		μs
I_{EN}	Current into RF_{IN}/E_N Pin				1	μA
P_{IN}	Input Power Range (Note 5)			0		dBm
				-30		
				-43		-13
	Logarithmic Slope (Note 8)	900 MHz		43.3		mV/dB
		1800 MHz		43.9		
		1855 MHz	36	43.5	51	
		1900 MHz		44.0		
		2000 MHz		43.2		
	Logarithmic Intercept (Note 8)	900 MHz		-46.7		dBm
		1800 MHz		-44.1		
		1855 MHz	-56	-44.3	-33	
		1900 MHz		-42.8		
		2000 MHz		-43.7		
V_{OUT}	Output Voltage	No RF Input Power Present		208	350	mV
R_{OUT}	Output Impedance	No RF Input Power Present		20.3	29 34	k Ω
e_n	Output Referred Noise	RF Input = 1800 MHz, -10 dBm, Measured at 10 kHz		700		nV/ \sqrt{Hz}
	Variation over Temperature	900 MHz, $RF_{IN} = 0$ dBm Referred to 25°C		+0.64 -1.07		dB
		1800 MHz, $RF_{IN} = 0$ dBm Referred to 25°C		+0.09 -0.86		
		1900 MHz, $RF_{IN} = 0$ dBm Referred to 25°C		+0 -0.69		
		2000 MHz, $RF_{IN} = 0$ dBm Referred to 25°C		+0 -0.86		

5.0 DC and AC Electrical Characteristics

Unless otherwise specified, all limits are guaranteed to $V_{DD} = 5.0V$; $T_J = 25^\circ C$. **Boldface** limits apply at temperature extremes. (Note 4)

Symbol	Parameter	Condition	Min	Typ	Max	Units
I_{DD}	Supply Current	Active Mode: $RF_{IN}/E_N = V_{DD}$ (DC), No RF Input Power Present.		5.3	7 9	mA
		Shutdown: $RF_{IN}/E_N = GND$ (DC), No RF Input Power Present.		0.49	4.5	μA
V_{LOW}	E_N Logic Low Input Level (Note 6)				0.8	V
V_{HIGH}	E_N Logic High Input Level (Note 6)		1.8			V
t_{on}	Turn-on- Time	No RF Input Power Present		2.1		μs
t_r	Rise Time (Note 7)	Step from No Power to 0 dBm Applied		4.5		μs
I_{EN}	Current Into RF_{IN}/E_N Pin				1	μA
$P_{IN, MIN}$	Input Power Range (Note 5)			-30 0		dBm
				-43 -13		dBV
	Logarithmic Slope (Note 8)	900 MHz		43.6		mV/dB
		1800 MHz		44.5		
		1900 MHz		44.5		
		2000 MHz		43.7		
	Logarithmic Intercept (Note 8)	900 MHz		-48.1		dBm
		1800 MHz		-45.6		
		1900 MHz		-44.2		
		2000 MHz		-45.6		
V_{OUT}	Output Voltage	No RF Input Power Present		211	400	mV
R_{OUT}	Output Impedance	No RF Input Power Present		23.4	29 31	k Ω
e_n	Output Referred Noise	RF Input = 1800 MHz, -10 dBm, Measured at 10 kHz		700		nV/ \sqrt{Hz}
	Variation over Temperature	900 MHz, $RF_{IN} = 0$ dBm Referred to $25^\circ C$		+0.89 -1.16		dB
		1800 MHz, $RF_{IN} = 0$ dBm Referred to $25^\circ C$		+0.3 -0.82		
		1900 MHz, $RF_{IN} = 0$ dBm Referred to $25^\circ C$		+0.34 -0.63		
		2000 MHz $RF_{IN} = 0$ dBm Referred to $25^\circ C$		+0.22 -0.75		

Note 1: Absolute Maximum Ratings indicate limits beyond which damage to the device may occur. Operating Ratings indicate conditions for which the device is intended to be functional, but specific performance is not guaranteed. For guaranteed specifications and the test conditions, see the Electrical Characteristics.

Note 2: Human body model: 1.5 k Ω in series with 100 pF. Machine model, 0 Ω in series with 100 pF.

Note 3: The maximum power dissipation is a function of $T_{J(MAX)}$, θ_{JA} and T_A . The maximum allowable power dissipation at any ambient temperature is $P_D = (T_{J(MAX)} - T_A)/\theta_{JA}$. All numbers apply for packages soldered directly into a PC board

Note 4: Electrical Table values apply only for factory testing conditions at the temperature indicated. Factory testing conditions result in very limited self-heating of the device such that $T_J = T_A$. No guarantee of parametric performance is indicated in the electrical tables under conditions of internal self-heating where $T_J > T_A$.

Note 5: Power in dBV = dBm -13 when the impedance is 50 Ω .

Note 6: All limits are guaranteed by design or statistical analysis

Note 7: Typical values represent the most likely parametric norm.

Note 8: Device is set in active mode with a 10 k Ω resistor from V_{DD} to RF_{IN}/E_N . RF signal is applied using a 50 Ω RF signal generator AC coupled to the RF_{IN}/E_N pin using a 100 pF coupling capacitor.

Connection Diagram

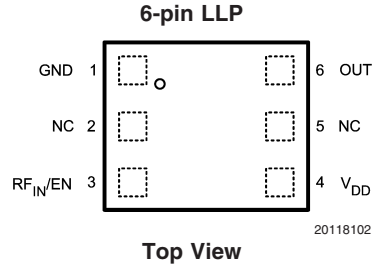

Pin Descriptions

	Pin	Name	Description
Power Supply	4	V_{DD}	Positive supply voltage
	1	GND	Power ground
	3	RF_{IN}/E_N	DC voltage determines enable state of the device (HIGH = device active). AC voltage is the RF input signal to the detector (beyond 450 MHz). The RF_{IN}/E_N pin is internally terminated with 50Ω in series with 45 pF.
Output	6	OUT	Ground referenced detector output voltage (linear in dBm)

Ordering Information

Package	Part Number	Package Marking	Transport Media	NSC Drawing
6-pin LLP	LMV227SD	A88	2k Units Tape and Reel	SDB06A
	LMV227SDX		9k Units Tape and Reel	

Note: This product is offered both with leaded and lead free bumps.

Block Diagram

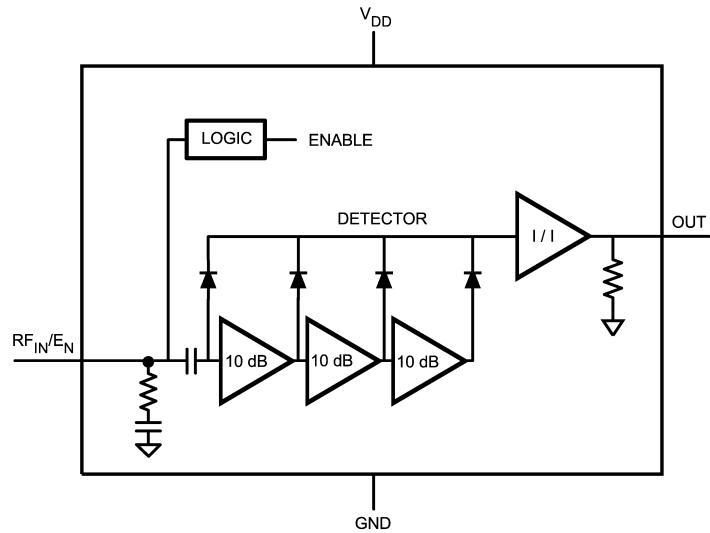

Typical Performance Characteristics Unless otherwise specified, $V_{DD} = 2.7V$, $T_J = 25^\circ C$.

Supply Current vs. Supply Voltage

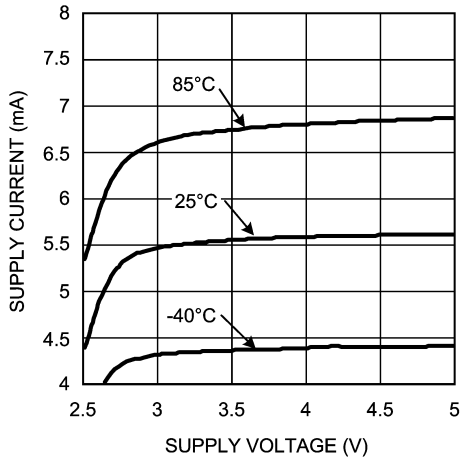

20118104

Output Voltage vs. RF Input Power

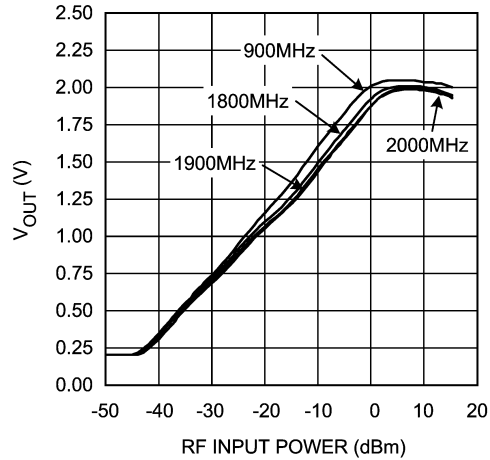

20118105

Output Voltage and Log Conformance vs. RF Input Power @ 900 MHz

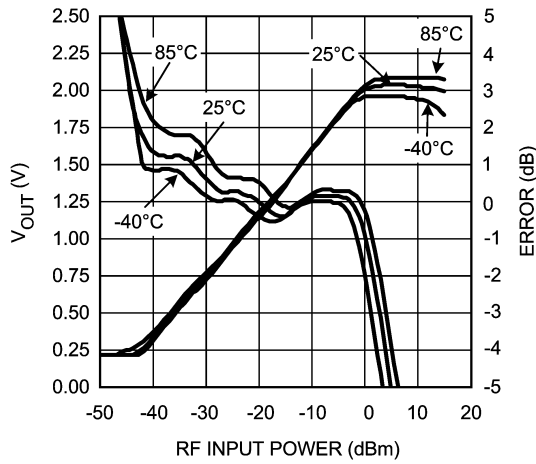

20118106

Output Voltage and Log Conformance vs. RF Input Power @ 1800 MHz

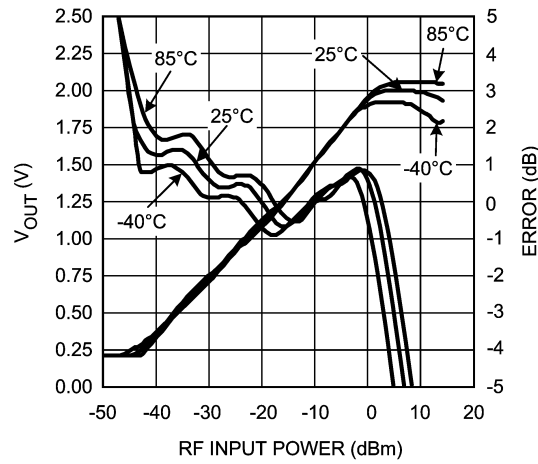

20118107

Output Voltage and Log Conformance vs. RF Input Power @ 1900 MHz

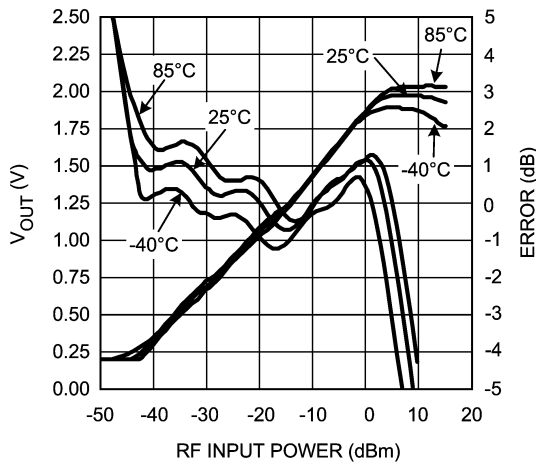

20118108

Output Voltage and Log Conformance vs. RF Input Power @ 2000 MHz

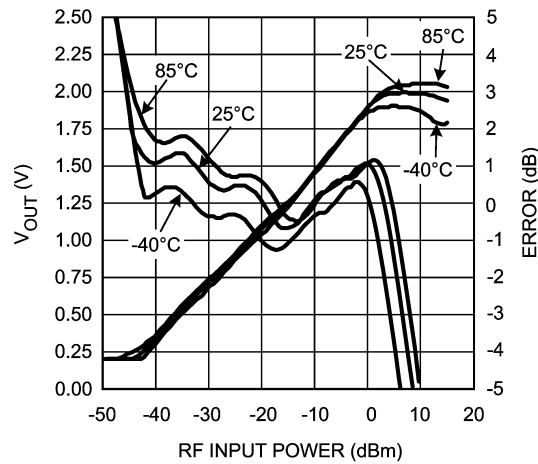

20118109

Typical Performance Characteristics Unless otherwise specified, $V_{DD} = 2.7V$, $T_J = 25^\circ C$. (Continued)

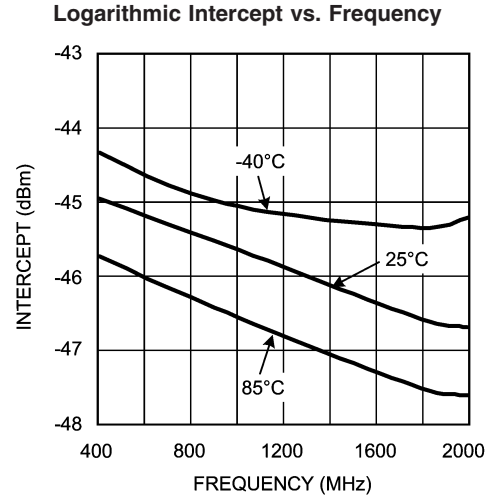
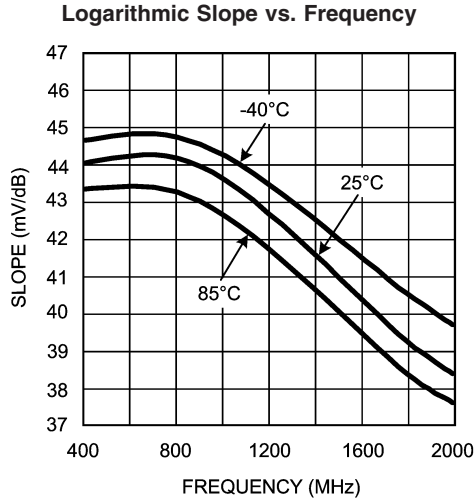

Output Variation vs. RF Input Power Normalized to 25°C @ 900 MHz

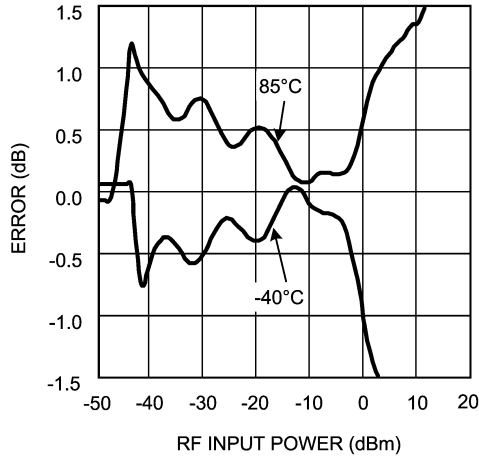

Output Variation vs. RF Input Power Normalized to 25°C @ 1800 MHz

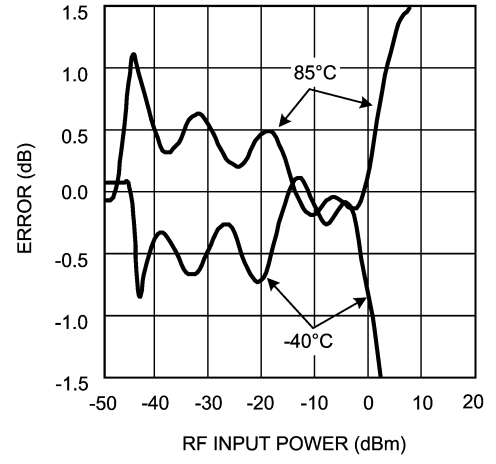

Output Variation vs. RF Input Power Normalized to 25°C @ 1900 MHz

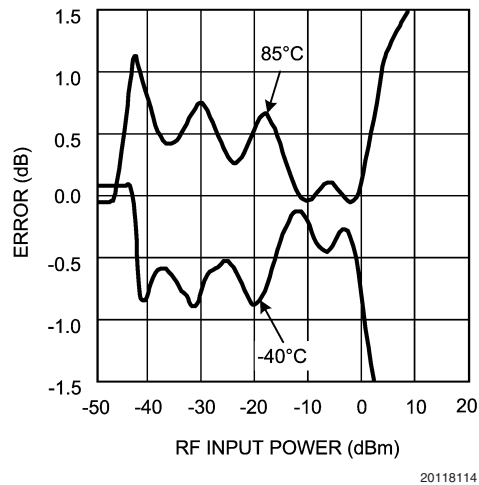

Output Variation vs. RF Input Power Normalized to 25°C @ 2000 MHz

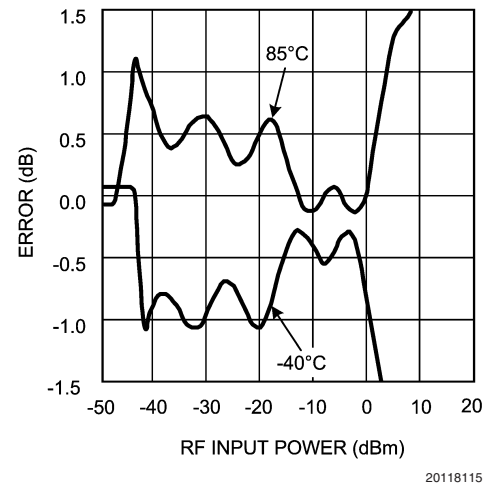

Typical Performance Characteristics Unless otherwise specified, $V_{DD} = 2.7V$, $T_J = 25^\circ C$. (Continued)

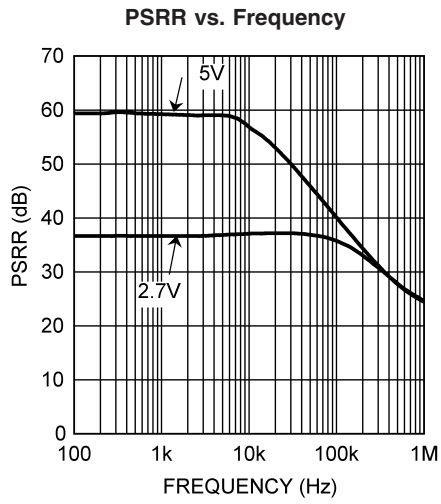

20118135

RF Input Impedance vs. Frequency @ Resistance and Reactance

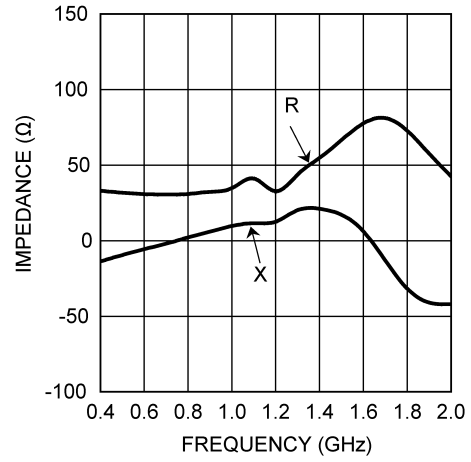

20118136

Application Notes

CONFIGURING A TYPICAL APPLICATION

The LMV227 is a power detector intended for CDMA and WCDMA applications. Power measured on its input translates to a DC voltage on the output through a linear-in-dB response. The detector is especially suited for power measurements via a high-resistive tap, which eliminates the need for a directional coupler. In order to match the dynamic output range of the power amplifier (PA) with the dynamic range of the LMV227's input, the high resistive tap needs to be configured correctly.

Input Attenuation

The constant input impedance of the device enables the realization of a frequency independent input attenuation to adjust the LMV227's dynamic range to the dynamic range of the PA. Resistor R_1 and the 50Ω input resistance of the device realize this attenuation (*Figure 1*). To minimize insertion loss, resistor R_1 needs to be sufficiently large. The following example demonstrates how to determine the proper value for R_1 .

Suppose the useful output power of the PA ranges up to +31 dBm and the LMV227 can handle input power levels up to 0 dBm. Hence, R_1 should realize a minimum attenuation of $31 - 0 = 31$ dB. The attenuation realized by R_1 and the effective input resistance R_{IN} of the detector equals:

$$A_{dB} = 20 \cdot \text{LOG} \left[1 + \frac{R_1}{R_{IN}} \right] = 31 \text{ dB} \quad (1)$$

Solving this expression for R_1 , using that $R_{IN} = 50\Omega$, yields:

$$R_1 = \left[10^{\frac{A_{dB}}{20}} - 1 \right] \cdot R_{IN} = \left[10^{\frac{31}{20}} - 1 \right] \cdot 50 = 1724\Omega \quad (2)$$

In *Figure 1*, R_1 is set to 1800Ω resulting in an attenuation of 31.4 dB

DC and AC Behavior of the RF_{IN}/E_N Pin

The LMV227 RF_{IN}/E_N pin has 2 functions combined:

- Shutdown functionality
- Power detection

The capacitor C and the resistor R_2 of *Figure 1* separate the DC shutdown functionality from the AC power measurement. The device is active when Enable = HI, otherwise it goes into a low power consumption shutdown mode. During shutdown the output will be LOW.

Capacitor C should be chosen sufficiently large to ensure a corner frequency far below the lowest input frequency to be measured. The corner frequency can be calculated using:

$$f = \frac{1}{2\pi(R_1 + R_{IN}) \frac{C \cdot C_{IN}}{C + C_{IN}}} \quad (3)$$

Where $R_{IN} = 50\Omega$, $C_{IN} = 45$ pF typical.

With $R_1 = 1800\Omega$ and C is 100 pF, this results in a corner frequency of 2.8 MHz

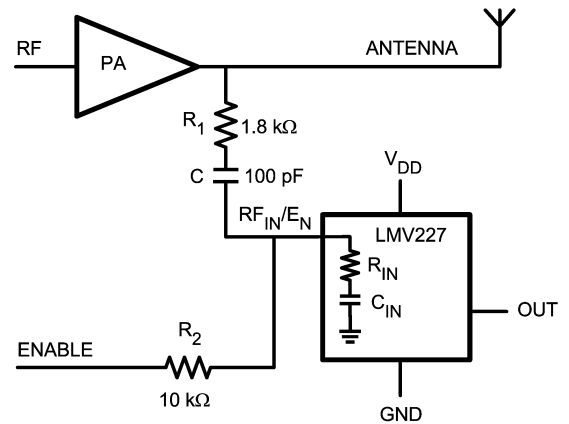

20118133

FIGURE 1. Typical Application

The output voltage is linear with the logarithm of the input power, often called "linear-in-dB". *Figure 2* shows the typical output voltage versus PA output power of the LMV227 setup as depicted in *Figure 1*.

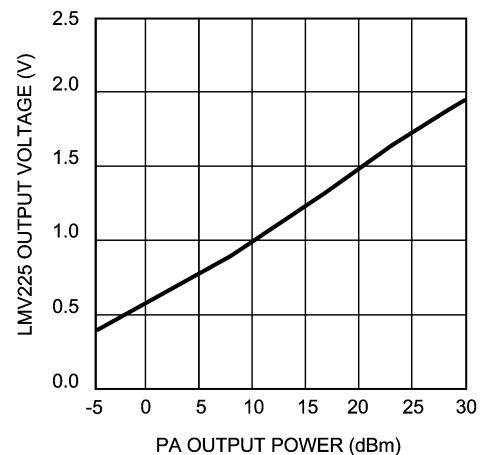

20118116

FIGURE 2. Typical Power Detector Response, V_{OUT} vs. PA Output Power

OUTPUT RIPPLE DUE TO AM MODULATION

A CDMA modulated carrier wave generally contains some amplitude modulation that might disturb the RF power measurement used for controlling the PA. This section explains the relation between amplitude modulation in the RF signal and the ripple on the output of the LMV227. Expressions are provided to estimate this ripple on the output. The ripple can be further reduced by connecting an additional capacitor to the output of the LMV227 to ground.

Estimating Output Ripple

The CDMA modulated RF input signal of *Figure 3* can be described as:

$$V_{IN}(t) = V_{IN} [1 + \mu(t)] \cos(2 \cdot \pi \cdot f \cdot t) \quad (4)$$

In which the amplitude modulation $\mu(t)$ can be between -1 and 1 .

Application Notes (Continued)

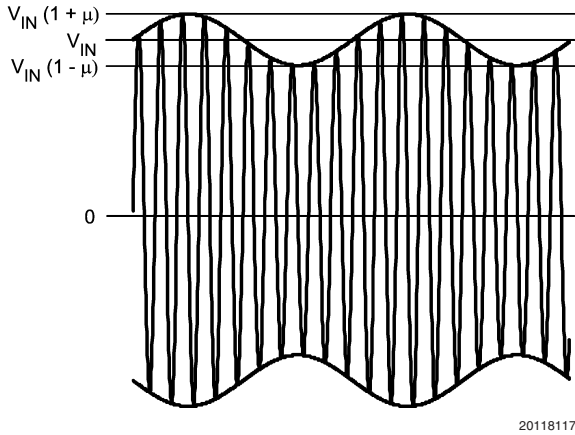

FIGURE 3. AM Modulated RF Signal

The ripple observed on the output of the detector equals the detectors response to variation on the input due to AM modulation (Figure 3). This signal has a maximum amplitude $V_{IN}(1+\mu)$ and a minimum amplitude $V_{IN}(1-\mu)$, where $1+\mu$ can be maximum 2 and $1-\mu$ can be minimum 0. The ripple can be described with the formula:

$$V_{RIPPLE} = V_Y \left[10 \text{ LOG} \left[\frac{V_{IN}^2 (1 + \mu)^2}{2R_{IN}} \right] + 30 \right] - V_Y \left[10 \text{ LOG} \left[\frac{V_{IN}^2 (1 - \mu)^2}{2R_{IN}} \right] + 30 \right] \quad (5)$$

P_{INMAX} IN dBm P_{INMIN} IN dBm

where V_Y is the slope of the detection curve (Figure 4) and μ is the modulation index. Equation 5 can be reduced to:

$$V_{RIPPLE} = V_Y \cdot 20 \text{ LOG} \left[\frac{1 + \mu}{1 - \mu} \right] \quad (6)$$

Consequently, the ripple is independent of the average input power of the RF input signal and only depends on the logarithmic slope V_Y and the ratio of the maximum and the minimum input signal amplitude.

For CDMA, the ratio of the maximum and the minimum input signal amplitude modulation is typically in the order of 5 to 6 dB, which is equivalent to a modulation index μ of 0.28 to 0.33.

A further understanding of the equation above can be achieved via the knowledge that the output voltage V_{OUT} of the LMV227 is linear in dB, or proportional to the input power P_{IN} in dBm. As discussed earlier, CDMA contains amplitude modulation in the order of 5 to 6 dB. Since the transfer is linear in dB, the output voltage V_{OUT} will vary linearly over about 5 to 6 dB in the curve (Figure 4).

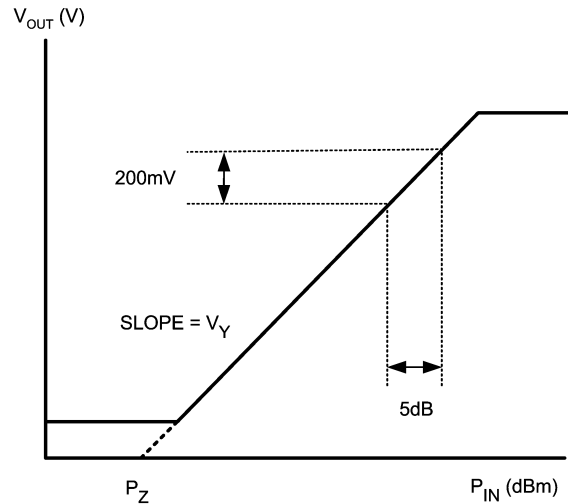

FIGURE 4. V_{OUT} vs. RF Input Power P_{IN}

Besides the ripple due to AM modulation, the log-conformance error contributes to a variation in V_{OUT} . For details see the typical performance characteristics curves. The output voltage variation ΔV_{OUT} thus is always the same for RF input signals which fall within the linear range (in dB) of the detector plus the log-conformance error:

$$\Delta V_O = V_Y \cdot \Delta P_{IN} + \text{Log Conformance Error} \quad (7)$$

In which V_Y is the slope of the curve. The log-conformance error is usually much smaller than the ripple due to AM modulation. In case of the LMV227, $V_Y = 40 \text{ mV/dB}$. With $\Delta P_{IN} = 5 \text{ dB}$ for CDMA, the $\Delta V_O = 200 \text{ mV}_{PP}$. This is valid for all V_{OUT} .

Output Ripple With Additional Filtering

The calculated result above is for an unfiltered configuration. When a low pass filter is used by shunting a capacitor of e.g. $C_{OUT} = 1.5 \text{ nF}$ at the output of the LMV227 to ground, this ripple is further attenuated. The cut-off frequency follows from:

$$f_C = \frac{1}{2 \pi C_{OUT} R_O} \quad (8)$$

With the output resistance of the LMV227 $R_O = 19.8 \text{ k}\Omega$ typical and $C_{OUT} = 1.5 \text{ nF}$, the cut-off frequency equals $f_C = 5.36 \text{ kHz}$. A 100 kHz AM signal then gets attenuated by $5.36/100$ or 25.4 dB. The remaining ripple will be less than 20 mV. With a slope of 40 mV/dB this translates into an error of less than 0.5 dB.

Output Ripple Measurement

Figure 5 shows the ripple reduction that can be achieved by adding additional capacitance on the output of the LMV227. The RF signal of 900 MHz is AM modulated with a 100 kHz sinewave and a modulation index of 0.3. The RF input power is swept while the modulation index remains unchanged. Without addition capacitance the ripple is about 200 mV_{PP} . Connecting a capacitor of 1.5 nF at the output to ground, results in a ripple of 12 mV_{PP} . The attenuation with a 1.5 nF capacitor is then $20 \cdot \log(200/12) = 24.4 \text{ dB}$. This is very close to the number calculated in the previous paragraph.

Application Notes (Continued)

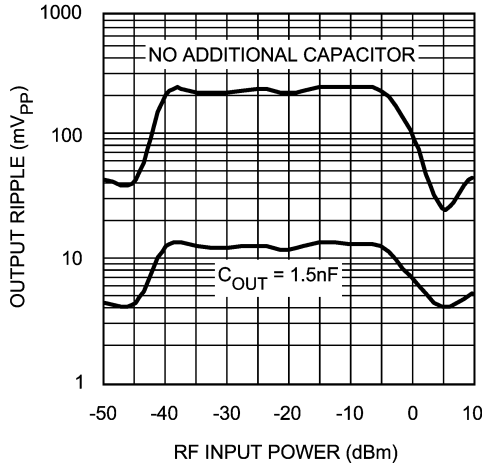

FIGURE 5. Output Ripple vs. RF Input Power

PRINCIPLE OF OPERATION

The logarithmic response of the LMV227 is implemented by a de-modulating logarithmic amplifier as shown in Figure 6. The logarithmic amplifier consists of a number of cascaded linear gain cells. With these gain cells, a piecewise approximation of the logarithmic function is constructed.

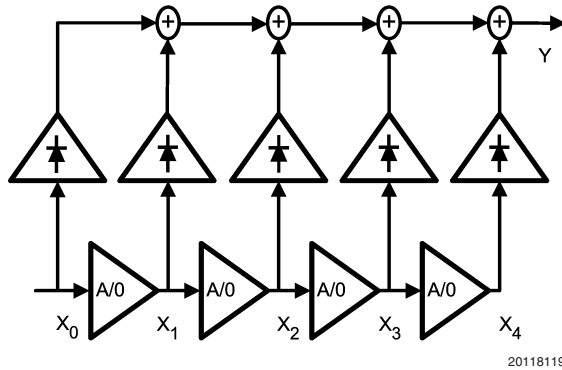

FIGURE 6. Logarithmic Amplifier

Every gain cell has a response according to Figure 7. At a certain threshold (E_K), the gain cell starts to saturate, which means that the gain drops to zero. The output of gain cell 1 is connected to the input of gain cell 2 and so on.

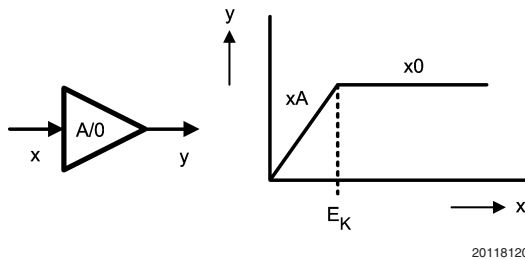

FIGURE 7. Gain Cell

All gain cell outputs are AM-demodulated with a peak detector and summed together. This results in a logarithmic function. The logarithmic range is about:

$$20 \cdot n \cdot \log(A)$$

where,

n = number of gain cells

A = gain per gaincell

Figure 8 shows a logarithmic function on a linear scale and the piecewise approximation of the logarithmic function.

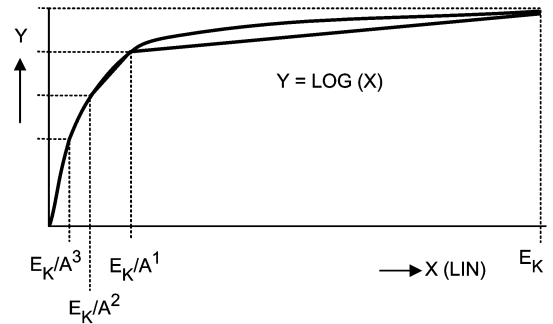

FIGURE 8. Log-Function on Lin Scale

Figure 9 shows a logarithmic function on a logarithmic scale and the piecewise approximation of the logarithmic function.

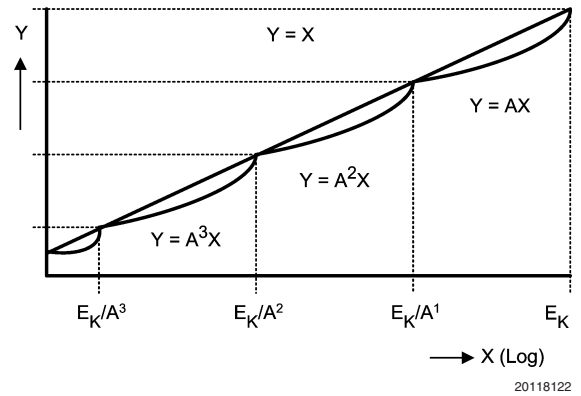

FIGURE 9. Log-Function on Log Scale

The maximum error for this approximation occurs at the geometric mean of a gain section, which is e.g. for the third segment:

$$\sqrt{\frac{E_K}{A^2} \cdot \frac{E_K}{A^1}} = \frac{E_K}{A\sqrt{A}}$$

The size of the error increases with distance between the thresholds.

Application Notes (Continued)

LAYOUT CONSIDERATIONS

For a proper functioning part a good board layout is necessary. Special care should be taken for the series resistance R_1 (*Figure 1*) that determines the attenuation. This series resistance should have a sufficiently high bandwidth. The

bandwidth will drop when the parasitic capacitance of the resistance is too high, which will cause a significant attenuation drop at the GSM frequencies and can cause non-linear behavior. To reduce the parasitic capacitance across resistor R_1 , it can be composed of several resistors in series instead of a single component.

Physical Dimensions inches (millimeters) unless otherwise noted

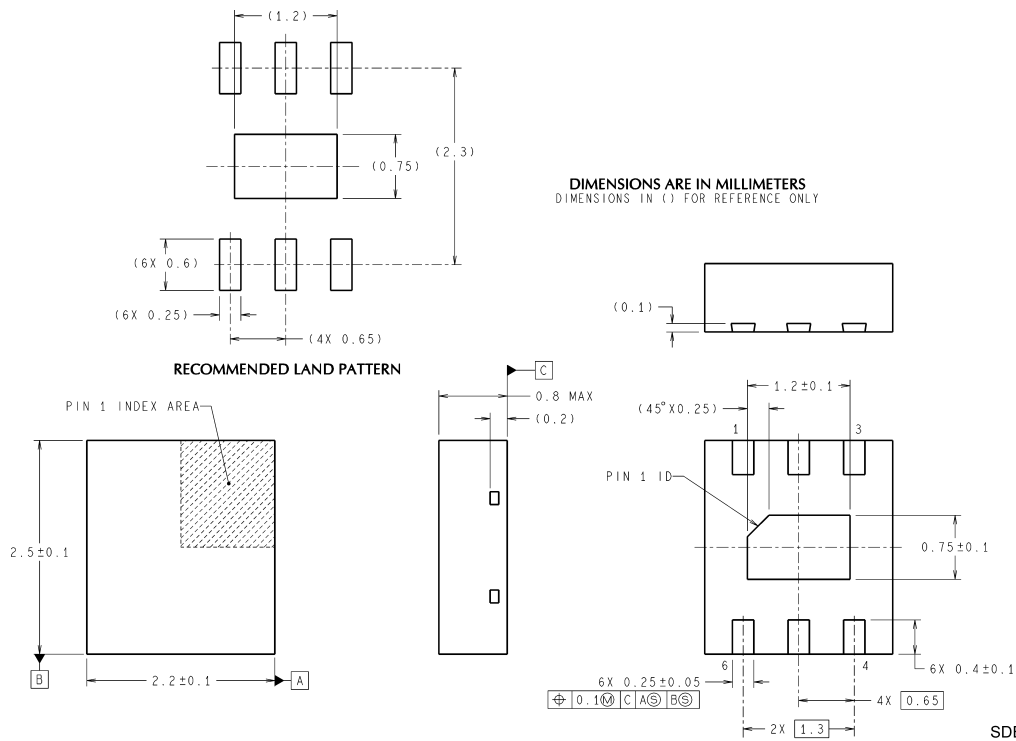

National does not assume any responsibility for use of any circuitry described, no circuit patent licenses are implied and National reserves the right at any time without notice to change said circuitry and specifications.

For the most current product information visit us at www.national.com.

LIFE SUPPORT POLICY

NATIONAL'S PRODUCTS ARE NOT AUTHORIZED FOR USE AS CRITICAL COMPONENTS IN LIFE SUPPORT DEVICES OR SYSTEMS WITHOUT THE EXPRESS WRITTEN APPROVAL OF THE PRESIDENT AND GENERAL COUNSEL OF NATIONAL SEMICONDUCTOR CORPORATION. As used herein:

1. Life support devices or systems are devices or systems which, (a) are intended for surgical implant into the body, or (b) support or sustain life, and whose failure to perform when properly used in accordance with instructions for use provided in the labeling, can be reasonably expected to result in a significant injury to the user.
2. A critical component is any component of a life support device or system whose failure to perform can be reasonably expected to cause the failure of the life support device or system, or to affect its safety or effectiveness.

BANNED SUBSTANCE COMPLIANCE

National Semiconductor follows the provisions of the Product Stewardship Guide for Customers (CSP-9-111C2) and Banned Substances and Materials of Interest Specification (CSP-9-111S2) for regulatory environmental compliance. Details may be found at: www.national.com/quality/green.

Lead free products are RoHS compliant.



National Semiconductor
Americas Customer
Support Center
Email: new.feedback@nsc.com
Tel: 1-800-272-9959

National Semiconductor
Europe Customer Support Center
Fax: +49 (0) 180-530 85 86
Email: europe.support@nsc.com
Deutsch Tel: +49 (0) 69 9508 6208
English Tel: +44 (0) 870 24 0 2171
Français Tel: +33 (0) 1 41 91 8790

National Semiconductor
Asia Pacific Customer
Support Center
Email: ap.support@nsc.com

National Semiconductor
Japan Customer Support Center
Fax: 81-3-5639-7507
Email: jpn.feedback@nsc.com
Tel: 81-3-5639-7560